



Vacuum Blender

Product Number: TMV1500AU

Instruction Manual

Thank you for your purchase. Before using this product, please read this instruction manual and use the product correctly. After reading the manual, please keep it close at hand for easy reference.

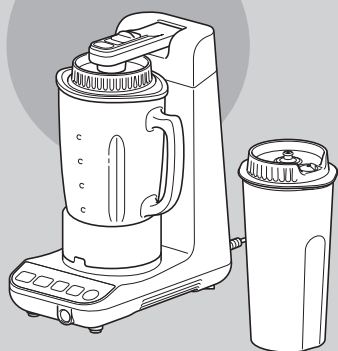

Table of Contents



Safety Warnings 1~4
Part names and functions 5~6



Before using the product 7~8
Using the blender9~16
Using the vacuum storage function ... 17~21
Advice on processing 22



Maintenance 23~26
About error notification 27~28



Troubleshooting 29



Specifications 29
Recipes 30



Precautions

- Before using this product, please read these precautions and use the product correctly.
- The precautions shown below are provided to ensure safe product use and to prevent harm to the user and those nearby, as well as to prevent property damage. Therefore, the precautions should always be followed.
- The precautions are classified as follows.

Danger

This description applies when it is assumed that the improper use of the product may cause death or serious injury and when the degree of urgency is high.

Warning

This description applies when it is assumed that the improper use of the product may cause death or serious injury.

Caution

This description applies when it is assumed that the improper use of the product may cause injury or property damage.

Symbols



This symbol is intended to notify the user of a description regarding prohibited usage.



(In the case of the symbol at left, "Disassembly prohibited.")



This symbol is intended to notify the user of a description regarding mandatory actions.



(In the case of the symbol at left, "The power plug must be removed from the outlet.")

Warning



Prohibition

Please do not use the product under any of the following states, as the power cord may be broken due to long-term use or improper use.

- When, during use, the product sometimes works and sometimes doesn't
- When the power cord is twisted and won't return to its original state
- When the base of the power cord has been deformed or damaged
- When the connection of the plug to the outlet is loose

These conditions may cause fire, electrical shock, burns, or a short circuit.

Please do not use the product with power other than AC 220-240 V. Otherwise, fire may result.

Please do not handle the power cord in any of the following ways.

- Bending it forcibly
- Twisting it
- Pulling it
- Putting heavy items on it
- Putting it close to a hot item
- Tucking it
- Making alterations to it
- Using it while having it tied in a bundle

Otherwise, fire or electrical shock may occur.

This appliance is not intended for use by persons (including children) with reduced physical, sensory or mental capabilities, or lack of experience and knowledge, unless they have been given supervision or instruction concerning use of the appliance by a person responsible for their safety. Children should be supervised to ensure that they do not play with the appliance.



Prohibition

This appliance shall not be used by children. Keep the appliance and its cord out of reach of children.

Or, please do not use the product while children are nearby.

Doing so may cause them injury.



Please do not leave the plastic bag packaging within reach of infants or children.

Doing so may allow them to mistakenly put the bag over their heads, possibly causing suffocation, etc.

Please do not leave the power plug cover within reach of infants.

Doing so may cause accident by swallowing.



Prohibition of disassembly

The disassembly, repair, or alteration of the product should only be done by a repair engineer. Otherwise, fire or electrical shock may occur.

If the power cord is damaged, it must be replaced by the manufacturer, its service agent, or similarly qualified persons in order to avoid a hazard.

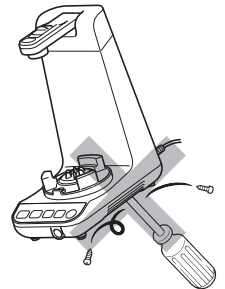

Prohibition of use in wet areas

Please do not submerge the main body in water.

Please do not allow water to come into contact with the main body.

Please do not plug and unplug the power cord with wet hands.

Doing so may cause electrical shock.

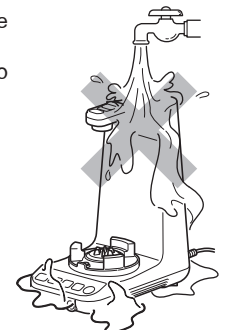

Precautions

Caution



Be sure to comply

Please ensure proper care of the cap after every use of the product. (Please see pp.23–26.)

Otherwise, product failure may result.

Please plug and unplug the power cord only after confirming that the power is OFF. Otherwise, injury may result.

Please hold the power plug itself when you pull the cord out from the outlet. Otherwise, damage to the power plug may result.



Pulling out the power plug

Always unplug the power plug from the outlet after using.

Always disconnect the appliance from the supply if it is left unattended and before assembling, disassembling or cleaning.

Otherwise, injury may result.



Prohibition

Please do not touch the cutter, as it is very sharp.

Be careful when handling the sharp cutter blades, emptying the container and during cleaning.

Otherwise, injury may result.



Please do not place your finger or a metal spoon, etc., in the blender container.

Doing so may cause an injury or a failure in the device.



Prohibition

Please never directly push the safety switch or the safety switch pin with your finger, a rod, etc.

Doing so may cause injury or failure.

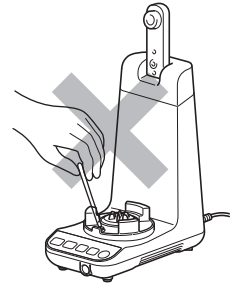

Please do not push the vacuumizing arm from above when the container unit does not have the cap in place.

Doing so may cause failure or an accident.

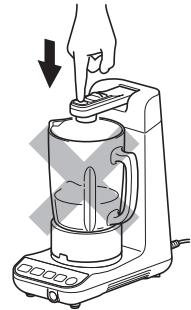

Please do not move the unit during operation.

Doing so may cause injury.

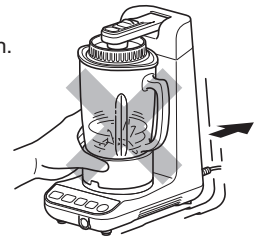

Please do not use the unit at a place that is unstable.

Doing so may cause an injury or the breakage of the product.

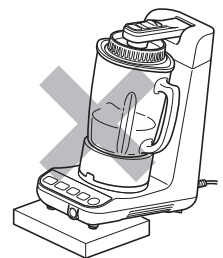

Precautions



Prohibition

Please do not put ingredients of a temperature higher than 40 C into the containers.

Doing so may cause injury due to the breakage of the container or the failure of the product.



When operation has stopped due to an excessive amount of ingredients or other causes, please do not use the unit as-is.

Doing so may cause the breakage of the product.



Please never perform no-load running. Please do not use the unit with ingredients of an amount less than the minimum amount.

Doing so may cause the breakage of the product.

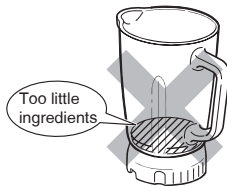

Please do not put in ingredients of an amount that exceeds the maximum scale value.

Rating capacity

Blender container: Please see p.12.

Smoothie container: Please see p.19.

Doing so may cause the failure of the product.

Please do not use the product for purposes other than food processing.

Doing so may cause the breakage of the product.

This appliance is intended for use in household and similar applications.



Prohibition

Please do not use unusable ingredients. (Please see p.11.)

Doing so may cause the breakage of the product.

Please do not put the product through a dishwasher or a dish dryer.

Doing so may cause the breakage of the product.

Please do not let the unit run continuously, exceeding the rated time. (Please allow it a rest for the specified period of time before next operation.) (Please see p.29.)

Otherwise, product failure may result.

Please do not use any container or part other than those meant for the purpose intended.

Please do not store food other than those processed using vacuum blending by means of vacuum storage.

Doing so may cause the failure of the product.



Be sure to comply

When you store food in the smoothie container by means of vacuum storage, please store such in a refrigerator.

Please do not store this in a freezer.

The product does not provide anti-bacterial effect. Please give special attention to storage.

Switch off the appliance and disconnect from supply before changing accessories or approaching parts that move in use.



This product contains recyclable materials. Do not dispose this product as unsorted municipal waste. Please contact your local municipality for the nearest collection point.

* The illustrations shown in the section for "Precautions" may differ from the actual product.



Locations and functions of parts

First, please check to see if the package has all the necessary parts and accessories. The seal material is already attached to the applicable parts. (Regarding how to remove the seals from the parts, please see p.24.)

Blender container unit

This is used to make smoothies or soups, as well as to crush ice. (Please see pp. 9-16.)

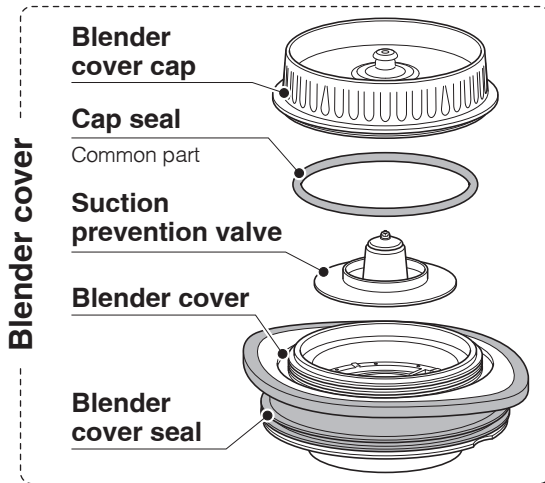

Blender container

Please comply with the maximum amount and the minimum amount as shown. (Please see p.12.)

* This part is not made of heat-resistant glass.

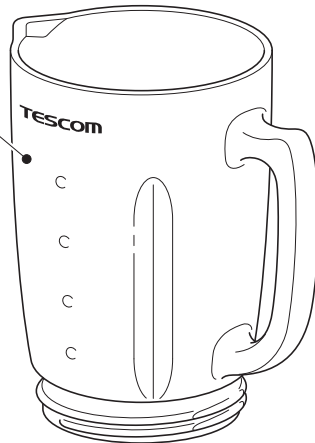

Blender container seal

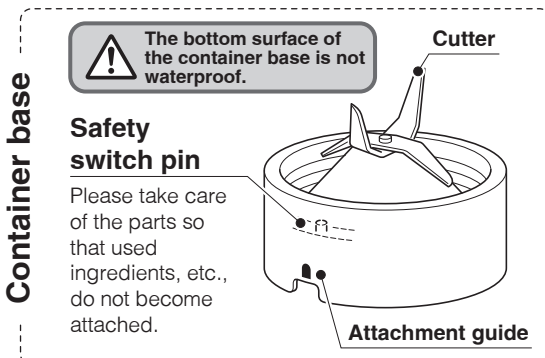

Smoothie container unit

This is used to store smoothies, etc., that are made using this product. (Please see pp.17-21.)

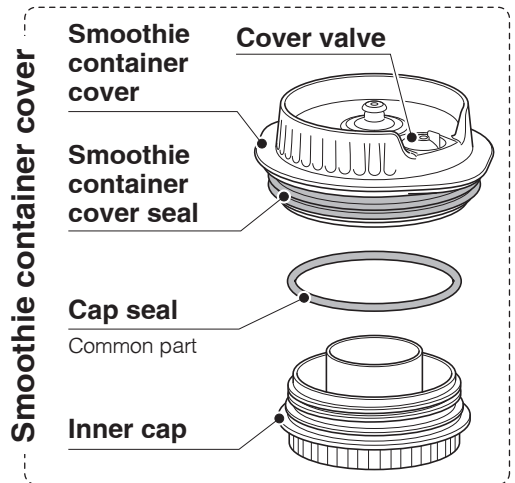

Smoothie container

Please comply with the maximum amount. (Please see p.19.)

* This is not a heat-resistant container.

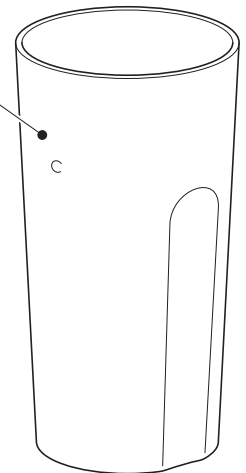

Brush with scraper

This is used to take out mixed ingredients and to help clean the unit.



Locations and functions of parts

Main body

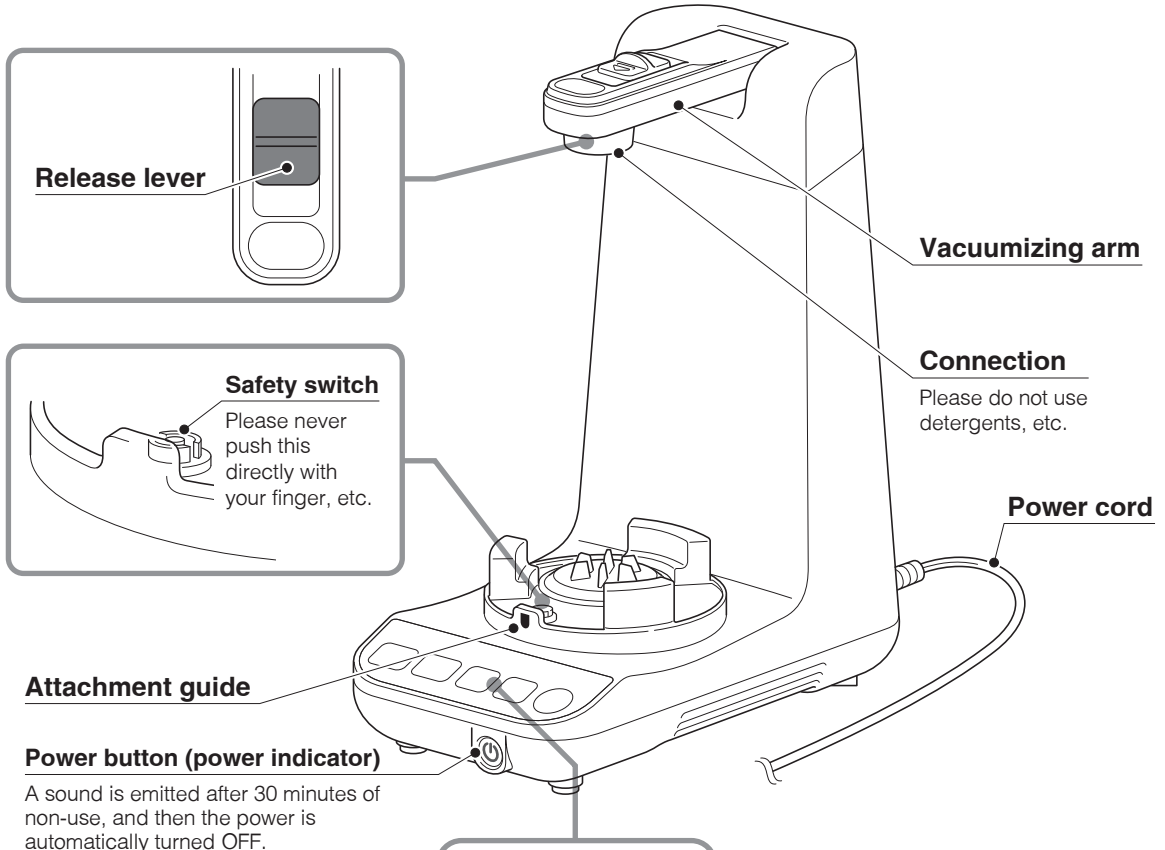

Control panel

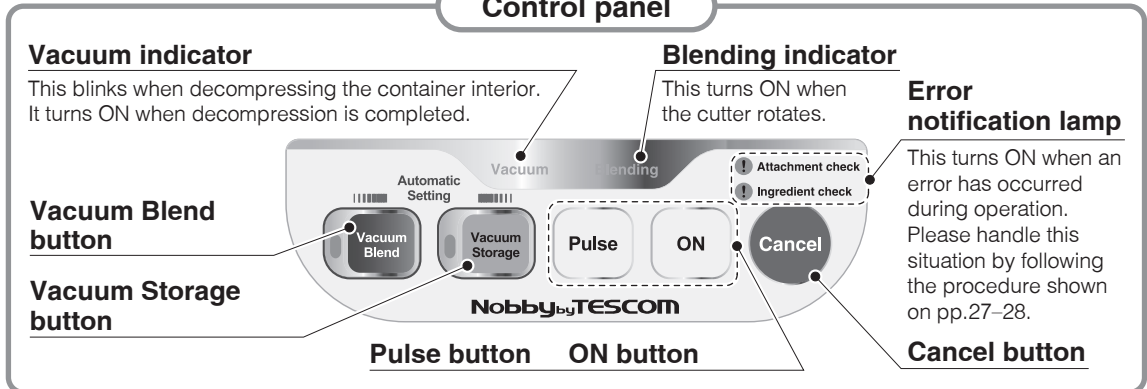

Recipe book

This provides an assortment of smoothie or soup recipes that can be made using this product.

* Please follow the procedures and the amounts prescribed in this book.

The specifications of the product and its parts are subject to change without notice.



Before using the product

About the vacuum blender

Traditional blenders allow a lot of air to mix in with the ingredients during blending, and for recipes where processing/blending is involved, such as smoothies*, food can become oxidized.

On the other hand, vacuum blenders can retard the process of oxidization by controlling incipient oxidization through vacuumization before blending the ingredients.

In addition, this blender can maintain the freshness of previously processed/blended food that has been vacuum stored, retarding oxidization, using its vacuum blending function. (However, such foods stored in a refrigerator should be consumed at the earliest possible opportunity because vacuum storage itself does not inhibit the growth of bacteria.)

* We refer to a smoothie as a drink made from the blending of fruit or vegetables—not from juicing.

Vacuum blending

When you push the Vacuum Blend button, the unit levels the ingredients with a pulse blend (once), decompresses the container interior up to a vacuum state, processes the food automatically, and stops.

Pulse (Once)

Decompression of the container interior

The air in the container is vacuumed out through the vacuumizing arm.

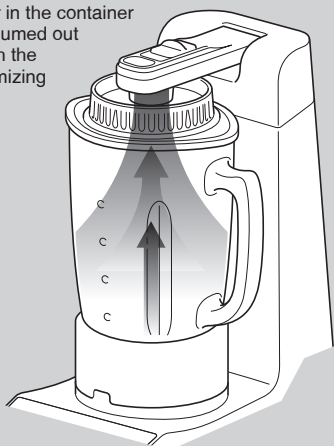

Stirring

Pulse (5 times)
Blending operation (1 minute)

Automatic stop

Vacuum storage

When you push the Vacuum Storage button, the unit decompresses the container interior up to a vacuum state and stops automatically.

Decompression of the container interior

The air in the container is vacuumed out through the vacuumizing arm.

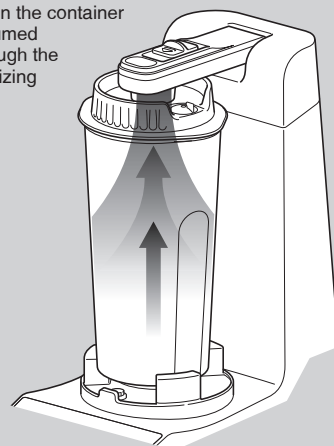

Automatic stop

Before using the product

* Vacuum: A state of pressure that is lower than atmospheric pressure

Please note:

If foreign matter is sucked into the main body, a failure may occur.
Please use the product by complying with the following instructions.

Potential foreign matter sucked into the main body

Powdered items (roasted soybean flour, cocoa powder, powdered sugar, protein, etc.)



Steam



Liquid material attached to the cover, etc.



Air bubbles and bubbles from mixed ingredients

Ingredients that are prone to produce air bubbles or other bubbles

- Ice cream, apples, etc., that contains a lot of air
- Milk, soy milk, dairy, etc., in which bubbles are prone to swell

To prevent failures

- Please use the ingredients after being processed using the blending function or after being dissolved completely.
Please see p.22 for details.

- Please use ingredients that have cooled down to at least below 40°C. (Otherwise, the container may break.)

- Please take care of each cover part every time after use and assemble the unit only after wiping off any moisture.

1. Please check the maximum amount for the container prescribed on p.12 and p.19, and use the unit only by complying with the capacity.
2. Please decant the liquid to the smoothie container so that bubbles are not produced.

When the container interior is decompressed, the air contained in the ingredients may come up as bubbles or the ingredients may bubble.

An amount less than the maximum amount (prescribed on p.12 and p.19) usually causes no problem. However, when bubbles are about to reach the cover, please push the Cancel button and stop the operation.

Please process ingredients blended halfway by using the blending function. (Please see p.16.)



Using the blender

When you use the blender for the first time or when using it after it has been stored for a while, please wash all parts other than the main body before use. (Please see pp.23–26.)

Assembling the blender container unit

Please note:

- Please perform assembly after taking due care and after wiping down any moisture. Adhered matter such as previous ingredients may cause an error.
- Please never touch the cutter located at the container base. Otherwise, injury may result.
- Please attach each part correctly. Otherwise, failure, error, or the leakage of the ingredients used may occur.
- Please attach the parts firmly so that no gap is generated between the blender container and the container base or between the blender container and the blender cover.

1 Assemble the blender cover.

(1) Attach the blender cover seal to the blender cover.

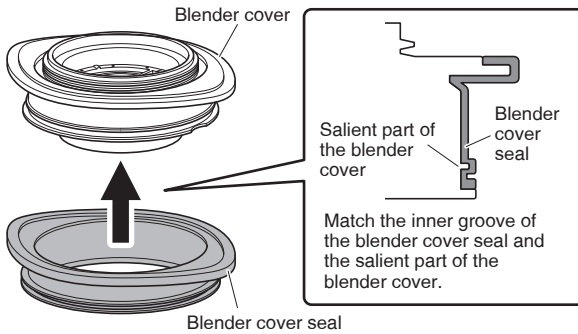

(2) Attach the cap seal to the blender cover cap.

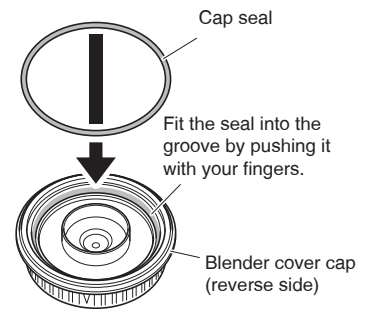

(3) Place the suction prevention valve in the middle of the blender cover, and then attach the blender cover cap from above.

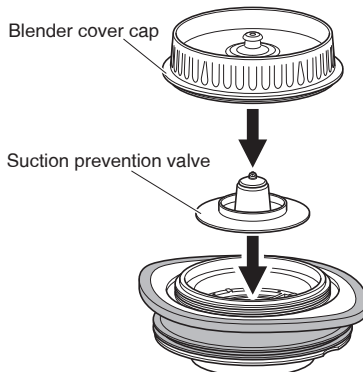

(4) Attach the blender cover cap by rotating it in the direction of the arrow.

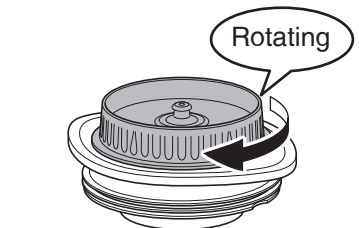

Point to note:

Rotate it until it stops.



Please never forget to attach the suction prevention valve. Otherwise, the product may break.

2 Attach the blender container to the container base.

- (1) Fit the blender container seal into the inner groove of the container base.
- (2) Fit the blender container into the container base, and attach it by rotating it in the direction of the arrow.

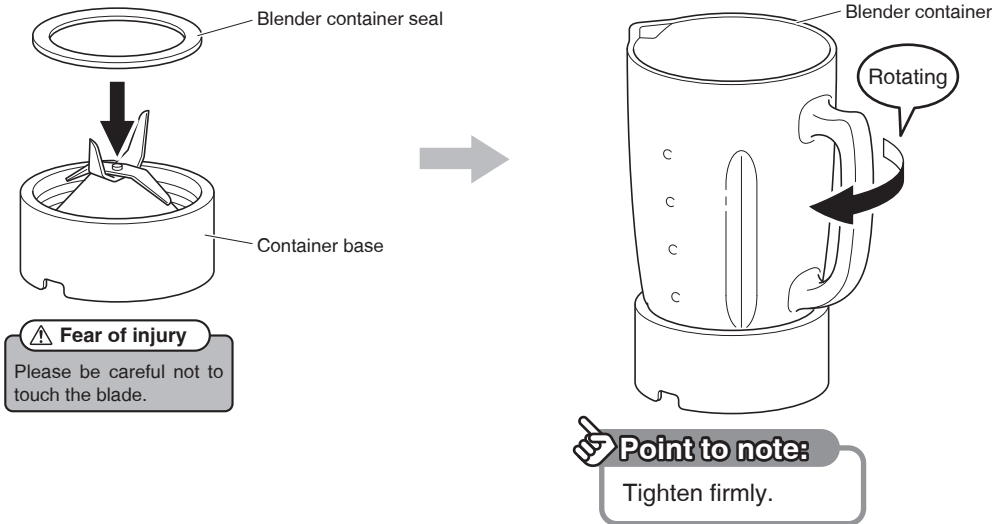

3 Put the ingredients in the blender container, and then put the blender cover on.

- (1) Match the shapes of the blender container and the blender cover.

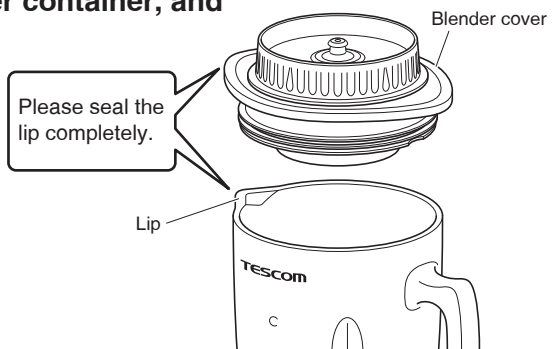

- (2) Fit the blender cover onto the blender container.

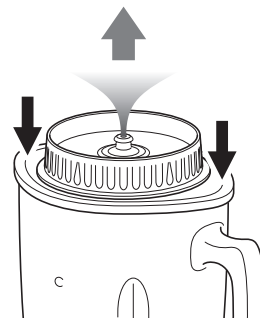
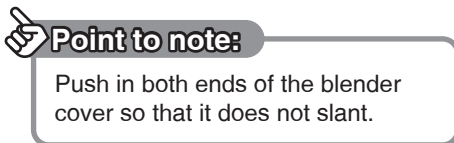

* Please do not cover up the hole in the center, as air needs to pass through the hole.

Using the blender

Unusable ingredients (causes of failure)

★Ingredients with a temperature higher than 40°C

★Meat or fish

★Flour such as wheat flour

★Hard or dry ingredients

- Frozen food (excluding fruit)
- Commercially available ice
- Dried bonito or dried soybeans
- Dried fruit, etc.

★Sticky ingredients

- Boiled red beans
- Japanese yams, etc.

★Powdered foodstuffs (Please see p.8.)

- * In the case of using the vacuum blending function

The blender should not be used for mincing ingredients, blending ingredients with little moisture, kneading, or preparing paste-like food (e.g. hamburger meat, dumpling stuffing, liquid diet foods, etc.), etc. Doing so may cause failure.

In addition, depending on the combination of ingredients or amount of moisture, the operation may be halted, in order to prevent failure. In such case, please handle the device following the procedure shown on pp.27–28.

Also, please use the accompanying recipe book and refer to “Advice on processing” on p.22 as a reference.

Preparation of ingredients

★Fruit

Thick-peel fruit should be peeled, cored, or seeded, and cut into sizes of 2 cm by 2 cm.

Bananas should be cut into round slices with a thickness of about 2 cm.



★Hard ingredients such as carrots

These should be peeled and cut into slices with a thickness of about 2–3 mm.

When they are still large, they should be further cut into pieces with a width of about 2 cm.



★Citrus fruit

These should be peeled, separated into sections, and seeded.



★Warm ingredients

These should be cooled down to below 40°C.

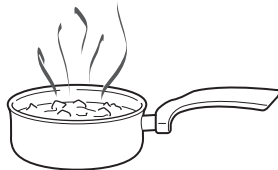

★Leafy vegetables, such as spinach

The stems should be cut off, and the leaves should be cut into pieces with a width of about 2 cm.

When you want to use more than the normal amount, the pieces should be cut smaller.

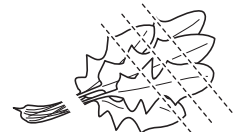

★Ice

Ice cubes of about 2.5 cm by 2.5 cm made with an ice cube tray for household use should be prepared.

* The number of ice cubes that can be used at one time is six or less.

★Frozen fruit

They should be cut smaller than 2 cm by 2 cm, and should be frozen. (Please see p.22.)

Putting the ingredients into the blender container

You should put the ingredients into the blender container in the order of liquids, soft food, and hard food.

When you plan to process food without putting liquid ingredients into the blender container, please see p.22.

Point to note:

Do not put too many ingredients into the blender container.

(1) Liquid ingredients, seasonings, etc.

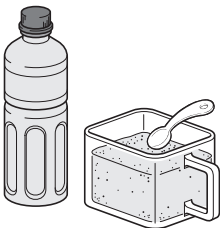

(2) Ingredients with high moisture content and soft ingredients



(3) Leafy vegetables

Please put ingredients in gently, instead of forcing them into the container.



(4) Hard ingredients, ingredients with low moisture content, honey, and ice

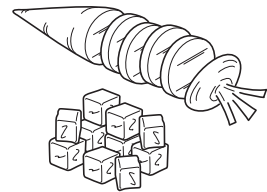

Capacity of the blender container



When you use the vacuum blending function with ingredients that are easy to bubble, such as soymilk, milk, dairy, or powdered solutions, the maximum amount should be 600 ml.

Otherwise, bubbles may be sucked into the main body, which may cause failure.

The amount of ice cream used for the vacuum blending function should be 200 ml or less at one time because ice cream contains air and swells when it is blended.

Maximum amount (780 ml)

The amount of ingredients should not exceed this line.

When you use the vacuum blending function with soymilk, milk, dairy, or powder solutions:

- (1) The amount of milk, soymilk, etc., should not exceed the line for the "Maximum amount of liquid such as soymilk."
- (2) The amount of other ingredients should not exceed the line for the "Maximum amount including all ingredients."

Minimum amount (200 ml)

The amount of ingredients should not fall below this line.

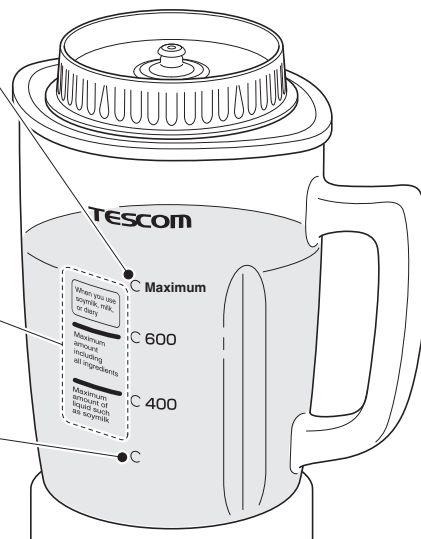

Using the blender

Using the vacuum blending function

This is an automatic setting for processing while retarding oxidization, by vacuumizing* the blender container interior.

Please note:

- Please assemble each part correctly and attach the blender cover firmly. Otherwise, a failure or error may occur.
- You must use the blender with an amount of ingredients that is less than the maximum amount. (Please see p.12.)

Please view the container from the side, and when the ingredients exceed the line, remove some with long utensil, etc., instead of pushing it down.

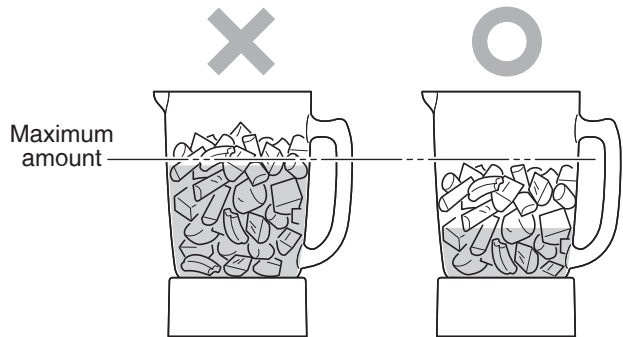

1 Put the ingredients into the blender container and attach the blender cover. (Please see pp.9–10.)

* Regarding the ingredients, please follow the description on pp.11–12.



Please take care of each part after use, and put the unit together only after wiping off any moisture. (Please see p.9 and p.25.)

2 Set the container and the cover into the main body.

(1) Stand the vacuumizing arm upright.

(2) Place the blender container unit on the main body while matching both attachment guides.

* Please be careful not to hit the vacuumizing arm.

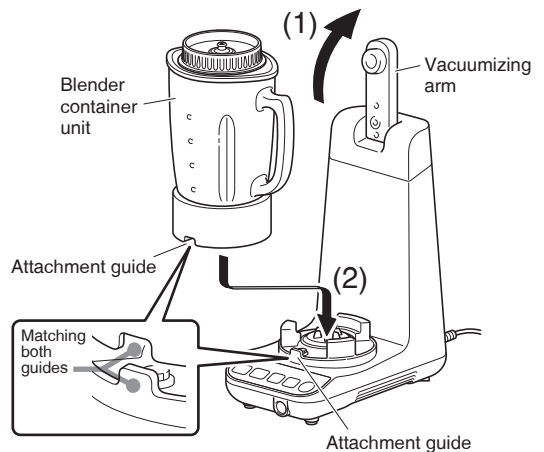

Using the blender

* Vacuum: A state of pressure that is lower than atmospheric pressure

(3) Pull down the vacuumizing arm and push on it with the palm of your hand.

* With a clicking sound, the vacuumizing arm is set into the blender cover.

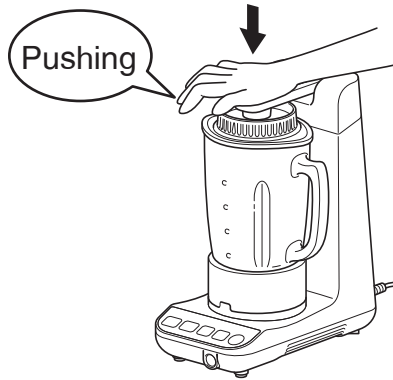

3 Insert the power plug into the outlet, and then turn ON the power by pushing the Power button.

● With a beep, the power indicator lights up.

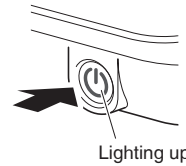

4 Push the Vacuum Blend button.

- The process begins in the order of: decompression of the container interior, pulsing (5 times), automatic blender operation (1 minute), and completion, with beeping. When you want to stop operation mid-way, please push the Cancel button.
- When the operation is stopped mid-way with repeated beeping as a warning, please follow the procedure shown on pp.27-28.

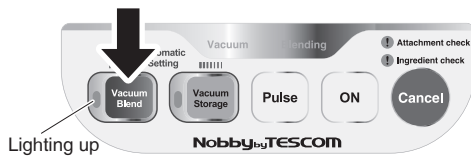

Point to note:

When you use the blender continuously, please do not forget to pay attention to the blender container cover.

* When the ingredients bubble while decompressing the container interior and when the bubbles are about to reach the cover, please push the Cancel button immediately and stop the operation.



When you have stopped the operation mid-way or when you want to perform further blending, you can continue processing the ingredients using the blending function.



Using the vacuum blending function in a state where ingredients, etc., are attached to the blender cover after stopping the operation may cause failure. (To prevent such a failure, even if you push the Vacuum Blend button after stopping the operation, the blender will not operate.)

Using the blender

5 Remove the blender container from the main body.

- (1) Push the Power button to turn OFF the power after the rotation has stopped completely.

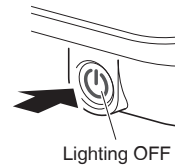

- (2) While pulling the release lever, stand the vacuumizing arm upright.

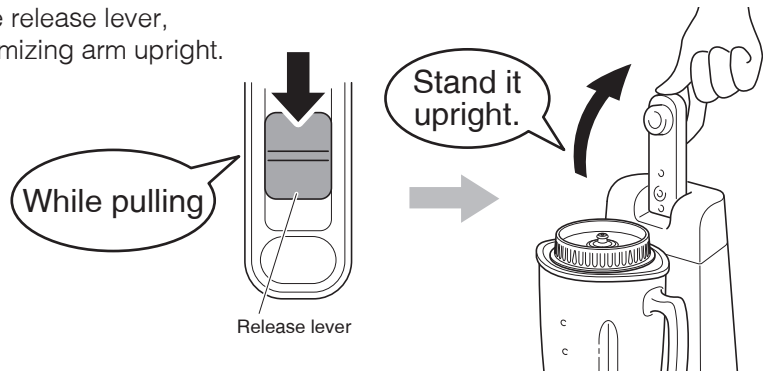

- (3) Remove the blender container.

*** Please be careful not to hit the vacuumizing arm.**

⇒When you want to apply the vacuum storage function when making smoothies, etc., you should follow the instructions on p.19.

- The blender container cannot be used for storage.

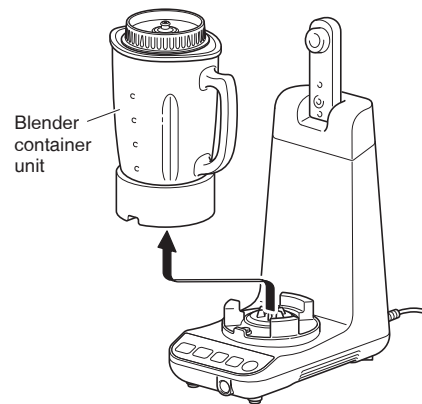

- (4) After using the blender, pull the plug out of the outlet, and ensure proper care immediately. (Please see pp.23–26.)

- When you use the blender continuously, please ensure proper care regarding the blender cover.
- The cover may be hard to remove because the container interior is decompressed. Please place the blender on a stable area, such as a table, and remove the cover while holding it firmly.



Using the blending function

1 Set the blender container unit into the main body and turn ON the power. (Please see procedures 1–3 on pp.13–14.)

* Regarding the ingredients, please follow the description on pp.11–12.

2 Processing

- (1) Push the Pulse button several times, with a push of about 1 second.
 - The cutter rotates when the Pulse button is pushed.
- (2) Push the ON button after the ingredients have started to mix, and operate the blender until they are blended to your preference.
- (3) Push the Cancel button to stop operation.
 - Even if you don't push the button, the blender will stop after 1 minute.

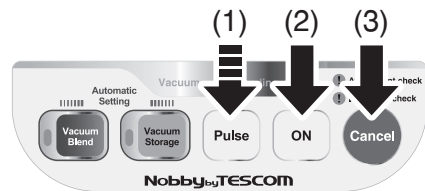

3 Remove the blender container from the main body, and take out the processed ingredients. (Please see procedure 5 on p.15.)



Please do not apply the vacuum storage function to what has been processed using the blending function. Or, please do not process the items again using the vacuum blending function. Oxidization cannot be retarded because air is already blended into the mix. In addition, this may cause the failure of the product.

Making crushed ice

1 Attach the blender container unit, add ice cubes (10 or less) made with an ice cube tray for household use, and then turn ON the power. (Please see procedures 1–3 on pp.13–14.)

• Please wipe off any moisture on the blender container.

2 Push the Pulse button several times, with a push of about 1 second, and crush the ice cubes until they are crushed to your preference.

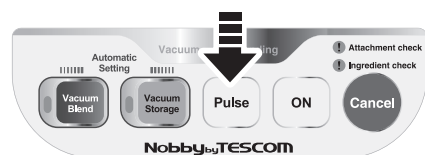



Using the vacuum storage function

When you use the blender for the first time or when using it after a period of non-use, please wash the parts other than the main body before using it. (Please see pp.23–26.)

Assembling the smoothie container unit

Please note:

- Please assemble the parts only after performing proper maintenance and after wiping down any moisture. Adhered matter such as previously used ingredients may cause an error.
- Please never forget to attach the cover valve and each seal material, and assemble each part correctly. Otherwise, failure or error may occur.
- Please attach the parts firmly so that no gap is generated between the smoothie container and the smoothie container cover.

1 Assemble the smoothie container cover.

(1) Attach the cover valve by pushing it into the mounting hole of the smoothie container cover.

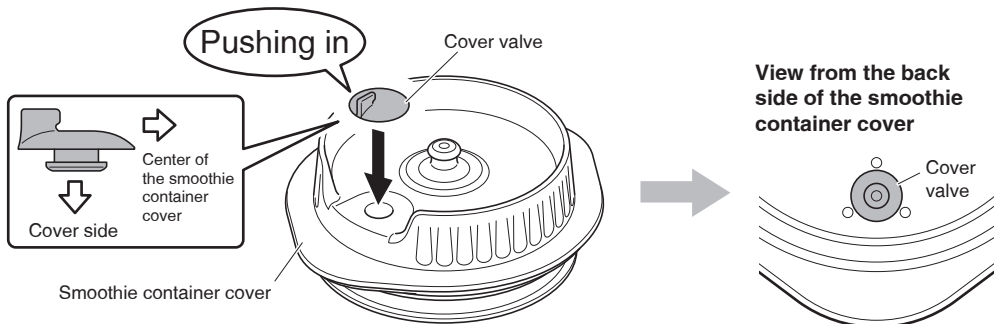

* When you attach the cover valve, please pay attention to the direction of the valve. If the direction is not correct, the valve may become hard to remove.

* Please confirm that the cover side end of the cover valve sits out of the back side surface of the smoothie container cover, with a round shape without being folded.

(2) Attach the smoothie container cover seal to the groove of the smoothie container cover.

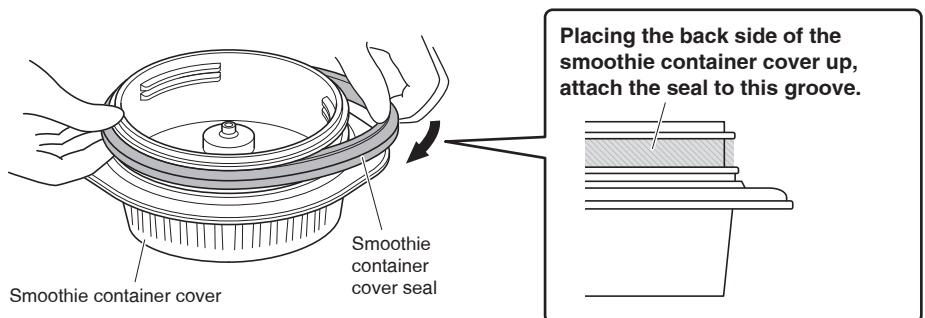

Using the vacuum storage function

2 Attach the inner cap.

- (1) As shown in the illustration, attach the cap seal to the inner cap.

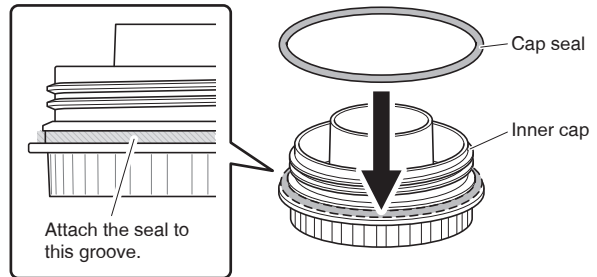

- (2) Fit the inner cap to the center of the smoothie container cover.

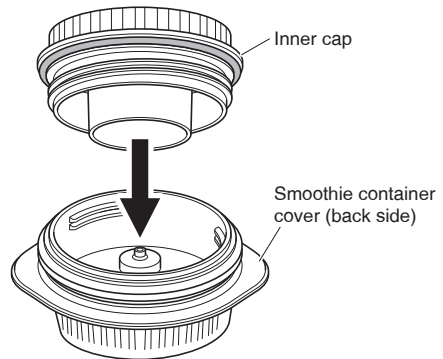

- (3) Attach the inner cap by rotating it in the direction of the arrow.

Point to note:
Rotate it until it stops.

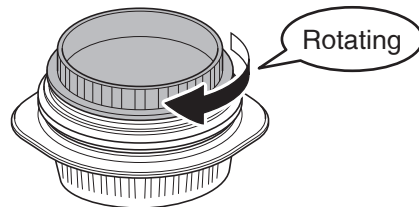

3 Put your smoothie ingredients, etc., into the smoothie container and cover the container with the smoothie container cover.

Point to note:
Push both ends of the smoothie container cover down so that the cover does not slant.

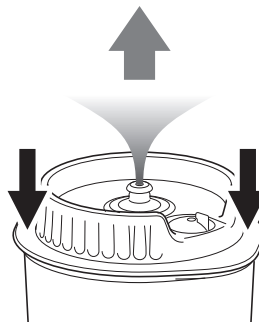

* Please do not cover up the hole in the center, as air needs to be able to pass through the hole.

Using the vacuum storage function

Using the vacuum storage function

This function is used for the later storage of smoothies, etc., already made using the vacuum storage function.

Freshness can be maintained because the smoothie is stored in the vacuum* smoothie container.

* This has no anti-bacterial effect. You must store the smoothie in a refrigerator. Depending on the ingredient combination, the food may separate during storage.

Please note:

- Please do not use ingredients with a temperature higher than 40°C. Or, please do not store the container in a freezer. Otherwise, container deformation or damage may occur.
- Please assemble the smoothie container cover correctly and fit all parts firmly. Otherwise, an error may occur.
- Please do not apply the vacuum storage function to what has not been processed with the vacuum blending function. Otherwise, a failure may occur.
- When you apply the vacuum storage function, please do so carefully so that the smoothies, etc., do not become adhered to the inner cap. Please pay attention to the following to prevent failure.
 - When you attach the smoothie container to the main body, please do not shake or tilt it.
 - When you apply the vacuum storage function to the remaining contents after opening the smoothie container and using some of the contents once, and if the smoothie ingredients, etc., are attached to the inner cap, take proper care regarding the cover.



1 Put smoothies, etc., made using the vacuum storage function in the smoothie container and cover the container with the smoothie container cover. (Please see pp.17–18.)

- Please pour it slowly to prevent bubbling.

★Capacity of the smoothie container

The smoothie container can store the maximum amount that can be made with the blender container at one time (780 ml). There is no minimum limit.

* Please do not put materials made using soymilk, milk, dairy, or powdered solutions up to the maximum amount (780 ml) because they are easy to bubble up when decompressing the container interior.

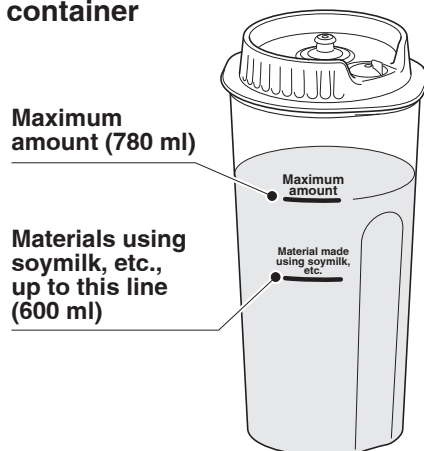

Using the vacuum storage function

* Vacuum: A state of pressure that is lower than atmospheric pressure

2 Attach the smoothie container unit to the main body.

(1) Stand the vacuumizing arm upright.

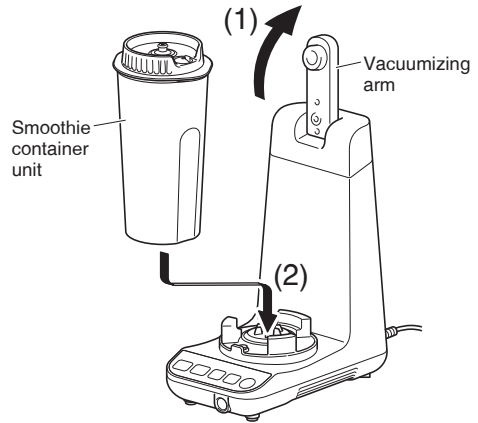

(2) Place the smoothie container unit on the main body.

* Please be careful not to hit the vacuumizing arm.

(3) Pull down the vacuumizing arm and push it in using the palm of your hand.

* With a clicking sound, the vacuumizing arm becomes attached to the smoothie container cover.



3 Insert the power plug into the outlet, and turn ON the power by pushing the Power button.

● With a beep, the power indicator lights up.

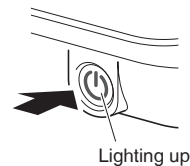

4 Push the Vacuum Storage button.

● When the operation stops mid-way with repeated beeps for warning, please follow the procedures shown on pp.27–28.

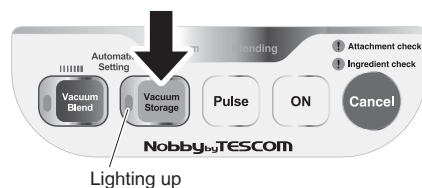

* When the ingredients bubble and when the bubbles are about to reach the cover, please push the Cancel button immediately and stop the operation.

Using the vacuum storage function

5 Remove the smoothie container unit from the main body.

- (1) Push the Power button to turn the power OFF after you hear the beeps.

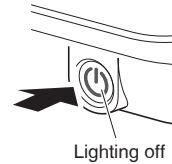

- (2) While pulling the release lever, stand the vacuumizing arm upright.

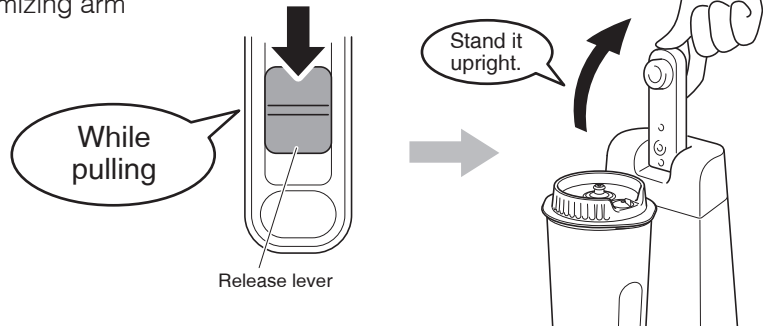

- (3) Remove the smoothie container unit.

*** Please be careful not to hit the vacuumizing arm.**

- (4) After using the smoothie container, pull the plug out from the outlet.

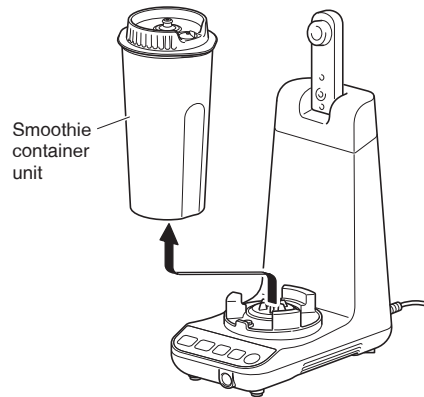

6 Store the container in a refrigerator.

- Please store the smoothie container upright.
- Depending on the combination of ingredients, the food may separate during storage.

The cover may be hard to dismount because the container interior is decompressed. When you drink a smoothie, etc., from the container, please dismount the cover following the procedures below.

- (1) Place it on a stable area, such as a table.
- (2) Allow air into the smoothie container by flipping the cover valve with your finger.
- (3) Dismount the cover while firmly holding the smoothie container.

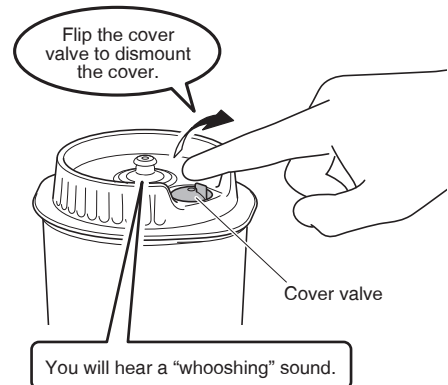



Advice on processing

“I want to make thick smoothies with no water.”

To prevent the unit from going idle liquids such as water are necessary, but when ingredients themselves provide enough moisture you can perform processing without any liquid.

●Point to note:

(1) Please use soft and moist ingredients as a base (those from which you can make juice by simply crushing them with your hands).

Examples: Citrus fruit, tomatoes, watermelons, grapes, melons, kiwis, etc.

Ingredients not suitable as a base: Pineapples, apples, etc.

(2) Please use a base ingredient of more than half (in weight) the total amount.

(3) Put the ingredients into the blender container in the order of base ingredient, leafy vegetables, ingredients with little moisture, and ice or frozen fruit, etc.

“Can I use commercially produced milk-based beverages as a liquid for the recipe?”

Yes, you can.

However, milk beverages should be processed at the same maximum amount as milk or soy milk, as it is easy for such beverages to bubble up. (Please see p.12.)

“I want to use frozen fruit.”

You can use frozen fruit at a size smaller than 2 cm by 2 cm. (When it is frozen as a lump, please separate it into pieces.)

Please never forget to put liquid such as water or other ingredients into the container at the beginning, with the frozen fruit last. If you put frozen fruit first, the blender may not operate due to the jamming of the cutter.

“I want to make a frozen-style smoothie.”

“Can I make soups with it?”

When you use boiled potatoes, you should add adequate liquid because sticking will occur during processing. Please add liquid at an amount more than 1.5 times (in weight) the solid. When the sticking is too strong, the blender may stop due to an error. In such case, please follow the procedures shown on pp.27–28.

“I want to use powdered ingredients (such as cocoa, roasted soybean flour, powdered sugar, and protein).”

When you use these with the vacuum blending function, they should previously be mixed with liquid and dissolved completely in a separate container, and then, they should be processed within the same maximum amount as for milk or soymilk. (Please see p.12.)

*** Please do not put materials mixed by shaking because that may cause a failure due to the suction of bubbles.**



Powdered ingredients that are hard to dissolve completely should be blended in a separate container after being processed or should be processed using the blending function (p.16).

Use of the vacuum blending function may cause a failure because lumps of flour or flour remaining without being dissolved may burst in the container during decompression and suctioned into the main body with air.



Care of the product

Please never forget to turn OFF the power and pull out the power plug from the outlet before you begin product maintenance.

Please note:

- Please do not use benzine, thinner, metal scrubbing brushes, polishing powder, or chemical-containing cloths for cleaning the product.
- Please do not use a dishwasher or a dish dryer.
- Please be careful not to lose seals, etc.

Before product maintenance

When the product is heavily soiled, please perform primary washing following the procedures below.

1 Following procedures 1–3 on pp.13–14,

attach the blender container unit containing water or lukewarm water (lower than 40 C), i.e., about a third of the container (about 250 ml), using neutral kitchen detergent, i.e.,

several drops to the main body. Then, turn ON the power.

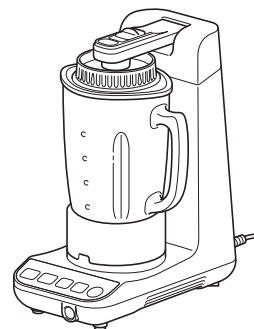

- ### 2
- (1) Operate the product for a few seconds by pushing the ON button.
 - (2) Then, stop it by pushing the Cancel button.

- Please adjust the operating time depending on the degree of soiling.

Failure warning:

Please never push the Vacuum Blending button during primary washing. Otherwise, failure may occur.

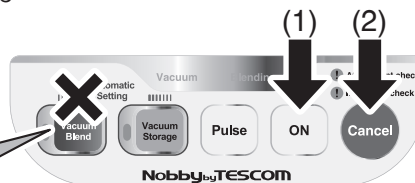

- ### 3
- After the rotation has stopped completely, turn OFF the power by pushing the Power button, and then dismantle the blender container unit from the main body. (Please see p.15.)**

- ### 4
- Pull out the power plug from the outlet.**

- ### 5
- Dismount the cover, discard the water (or the lukewarm water), rinse the container lightly with water, disassemble the product, and ensure the care of each part.**

Dismounting each part

Blender container

- (1) Dismount the container base by rotating it in the direction of the arrow.

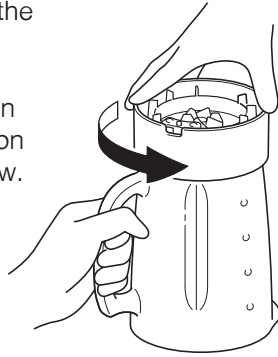

- (2) Dismount the blender container seal from the container base.

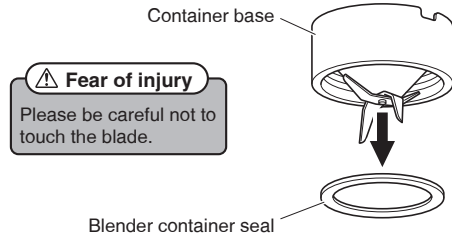

Blender cover

- (1) Dismount the blender cover cap by rotating it in the direction of the arrow, and then separate each part.



*When the cap seal is hard to be removed, please pry up the side of the seal using a thin cylindrical object with a point, such as a toothpick.

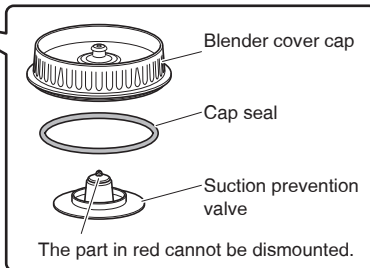

- (2) Dismount the blender cover seal while pulling it outward.

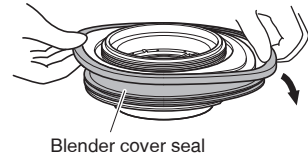

Smoothie container cover

- (1) Dismount the inner cap by rotating it in the direction of the arrow, and then separate each part.

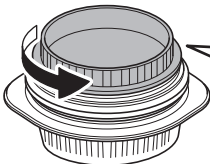

*When the cap seal is hard to be removed, please pull up the side of the seal using a thin cylindrical object with a point, such as a toothpick.

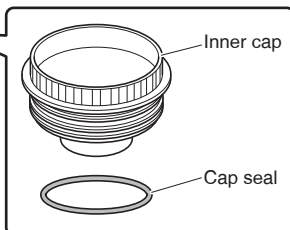

- (2) Dismount the smoothie container cover seal while pulling it outward.

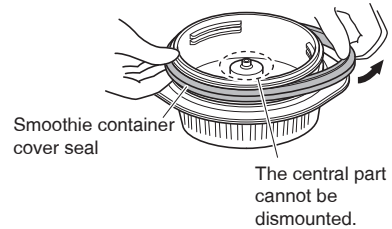

- (3) Pull out the cover valve by flipping it.

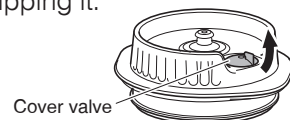

Care of the product



You must not use a dishwasher or a dish dryer.

Main body

Squeeze out a soft cloth soaked in soapy water or a neutral detergent diluted with water and wipe down the main body.

No moisture

Please be careful not to get the main body wet because it cannot be washed with water. Otherwise, failure may occur.

Please wipe the connections of the main body with a well-squeezed damp cloth without using detergent.

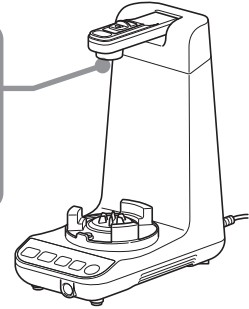

Blender container unit

Blender container and blender container seal

Disassemble the container (see p.24), wash each part with a sponge using neutral detergent, and rinse it well with water or lukewarm water (lower than 40°C).

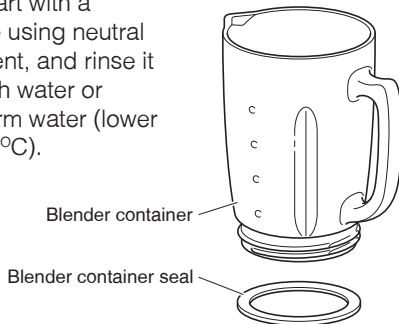

Blender cover

Disassemble the container (see p.24), wash each part with a sponge or the accompanying brush with scraper using neutral detergent, and rinse it well with water or lukewarm water (lower than 40°C).

*** Please do not completely soak and wash the blender cover.**

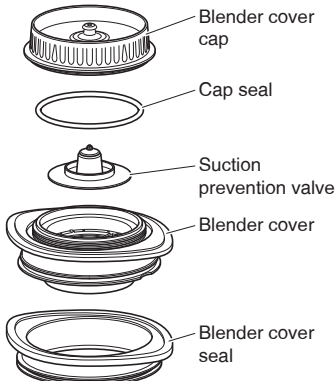

Container base

Wash the side with the cutter with the brush with scraper using neutral detergent, being careful not to touch the blade, and rinse the container base well with water or lukewarm water (lower than 40°C). Squeeze out a soft cloth soaked in soapy water or neutral detergent diluted with water, and wipe the back side of the container base.

Container base

- Please take care regarding parts around the safety switch pin.

No moisture

Please be careful not to get the back side of the container base wet because it cannot be washed with water. Otherwise, failure may occur.

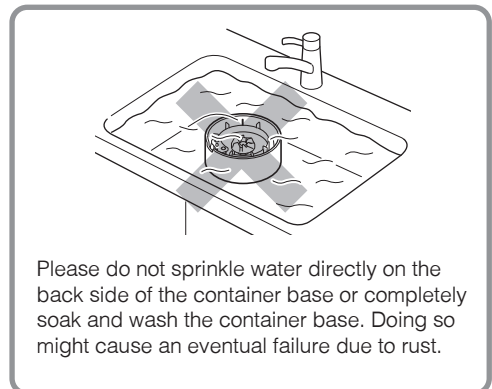
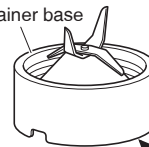

Please do not sprinkle water directly on the back side of the container base or completely soak and wash the container base. Doing so might cause an eventual failure due to rust.

Smoothie container unit

Smoothie container

Disassemble the container (see p.24), wash each part with a sponge using neutral detergent, and rinse it well with water or lukewarm water (lower than 40°C).

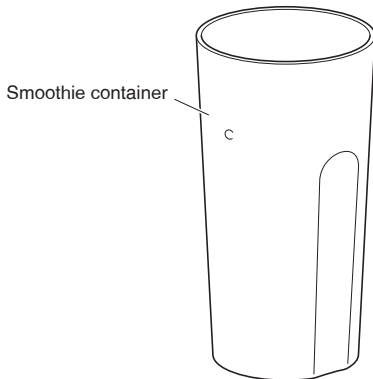

Smoothie container cover

Disassemble the cover (see p.24), wash each part with a sponge or the accompanying brush with scraper using neutral detergent, and rinse it well with water or lukewarm water (lower than 40°C).

*** Please do not completely soak and wash the cover. Other ingredients, etc., may become adhered.**

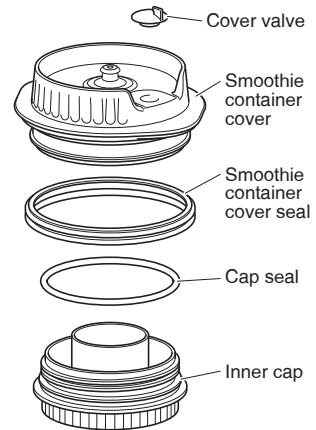

Post-maintenance

- 1 After performing maintenance, wipe all parts carefully, dry them sufficiently, and re-assemble them.**

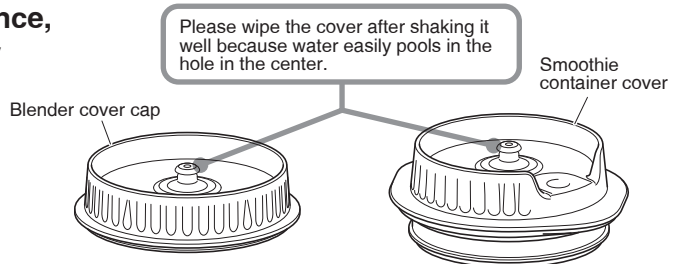

- 2 Attach the blender container unit to the main body and store it in a place where it is not exposed to direct sunlight, with adequate ventilation ensured.**

*** Remaining moisture might promote rust or mold.**





About error notification

This product stops operation automatically with warning beeps and lighting when it detects an error.

Please handle it following the procedures below to prevent injury or failure.

1 (1) Check the lit lamp, and (2) push the Cancel button to release the error.

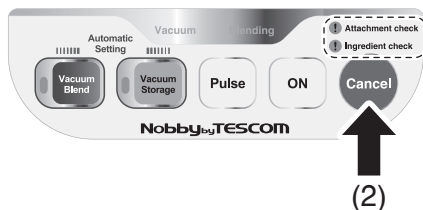

(1) Check the lit lamp.

(2)

There may be a case where the Power button lamp blinks while the error notification lamp is unlit. Please also confirm the Power button.

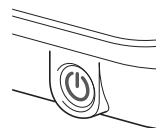

2 Push the Power button to turn OFF the power, and pull out the power plug from the outlet.

When the Attachment check lamp is lit

When any part is attached incorrectly, the Attachment check lamp becomes lit.

Probable causes		Handling method
The product stopped operation soon after you pushed the Vacuum Blender button or the Vacuum Storage button.	Have you set the vacuumizing arm correctly?	<ul style="list-style-type: none"> Please push the vacuumizing arm with the palm of your hand until you hear a clicking sound. (Please see p.14 and p.20.)
The product stopped operation when decompressing the container interior.	Is each cover on firmly?	<ul style="list-style-type: none"> Please attach the cover firmly so that no gap is generated between the container and the cover. Please cover the blender container lip completely with the blender container cover. (Please see p.10.)
	Is each cover part assembled correctly?	<ul style="list-style-type: none"> Please check if there is any absence or incorrect mounting of seals or parts. (Please see p.9, p.10, p.17, and p.18.) Please firmly mount the blender cover cap and the inner cap by rotating them completely. Please check if the end of the cover valve (attached to the smoothie container cover) is not folded. (Please see p.17.)
	Are the blender container and container base assembled correctly?	<ul style="list-style-type: none"> Please firmly mount the blender container to the container base by rotating it completely. (Please see p.10.) Please never forget to mount the blender container seal.

About error notification

- 3** Dismount each container unit from the main body. (Please see p.15 and p.21.)

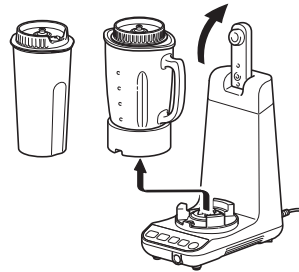

- 4** Check the probable causes below and handle the unit responding to the causes shown.

When the Ingredient check lamp is lit

When the motor is overloaded, the Ingredient check lamp becomes lit. After transferring the contents of the blender container to another container, please handle it as below.



*** When you process the ingredients again using the vacuum blending function, please do so after paying attention to the cover.**

Probable causes		Handling method
The product stopped operation when decompressing the container interior.	There may be ingredients or bubbles inside the blender cover cap.	<ul style="list-style-type: none"> ● Please take good care of the cover and wipe off any moisture carefully. (Please see p.25.) ● Please remove any bubbles inside the container.
	Are you using too many ingredients?	<ul style="list-style-type: none"> ● Please reduce the ingredients used and comply with the operating capacity of the blender container. (Please see p.12.)
The product stopped operation after the cutter started to rotate.	Are you using ingredients that are actually unusable?	<ul style="list-style-type: none"> ● Please remove any unusable ingredients. (Please see p.11.)
	Are you using any hard-to-blend ingredients (due to overly large size), or is the liquid dilution too low, etc.?	<ul style="list-style-type: none"> ● Please cut the ingredients into smaller pieces. ● Please add liquid, such as water.
	Are there ingredients stuck between the cutter parts?	<ul style="list-style-type: none"> ● Please dismount the blender container from the container base (please see p.24) and remove the stuck matter using a long slender utensil, etc.

When the Power button lamp is lit

As the safety device of the motor is in operation, please allow the unit to rest for more than 30 minutes.



Troubleshooting

Please check the following, and if a problem still persists, please stop operation immediately.

When	Probable causes	Handling method
Even if you push the button, the product doesn't operate. The product has stopped operation. (The error notification lamp is lit.)		<ul style="list-style-type: none"> ● Please handle the unit following the procedures shown on pp.27–28.
Even if you push the button, the product doesn't operate. The product has stopped operation. (The power lamp is blinking.)	<ul style="list-style-type: none"> ● Ice is stuck between the parts. ● The product has been operating for more than the rated time. ● The safety mechanism became engaged due to a rise in temperature. 	<ul style="list-style-type: none"> ● Please remove any ice stuck between the parts. ● Please allow it to rest for more than 30 minutes.
Even if you push the Vacuum Blender button, the product doesn't operate.	<ul style="list-style-type: none"> ● After blending by pushing the Pulse button and the ON button, you accidentally pushed the Vacuum Blender button. (The protective function began operating.) 	<ul style="list-style-type: none"> ● Please perform processing using the blender function. (Please see p.16.)
You cannot turn the power ON.	<ul style="list-style-type: none"> ● The power plug has been mistakenly pulled out from the outlet. 	<ul style="list-style-type: none"> ● Please re-insert the power plug into the outlet.
Water leakage occurs.	<ul style="list-style-type: none"> ● The blender container and the container base are not firmly connected. ● A seal is mounted incorrectly. 	<ul style="list-style-type: none"> ● Please tighten these completely until the water leakage stops. ● Please assemble them again. ● Please see pp.9–10.
Smoke appears. The cord has twisted and won't go back to its original state.		<p>Please stop operation immediately.</p>

Specifications	Name of product	Vacuum blender	Weight	Main body: 2.2 kg Blender container and container base: About 1.5 kg Smoothie container: 340 g
	Product number	TMV1500AU		
	Power source	220–240 V ~ 50–60 Hz		
	Power consumption	300 W	Size	H327 x W148 x D275 (mm)
	Rotating speed	9,500 rpm	Length of cord	1.2m
	Container capacity	Blender container: Max. 780 ml, min. 200 ml Smoothie container: Max. 780 ml		



Recipes

Carrot and tomato smoothies.

- 1, Water 300ml
- 2, Carrot 120g
- 3, Tomato 120g
- 4, Apple 120g
- 5, Syrup 20ml

Cut all ingredients into 2cm cubes. Put the ingredients in order into the blender container and press the "Vacuum blender" button.

Banana and royal jelly smoothies.

- 1, Water 50ml
- 2, Milk 250ml
- 3, Banana 100g
- 4, Honey 10ml
- 5, Royal jelly 10ml

Cut all ingredients into 2cm cubes. Put the ingredients in order into the blender container and press the "Vacuum blender" button.

Spinach and pineapple smoothies.

- 1, Water 250ml
- 2, Papaya 100g
- 3, Spinach 30g
- 4, Pineapple 100g
- 5, Apple 30g
- 6, Syrup 10ml

Cut all ingredients into 2cm cubes. Put the ingredients in order into the blender container and press the "Vacuum blender" button.

Warranty

1. Care With You Pty Ltd (the "Importer") warrants the vacuum blender (the "Product") is free from faults in manufacture and materials for one (1) year ("Warranty Period") from the date of purchase.
2. Our Products come with guarantees that cannot be excluded under the relevant Australian Consumer Law. If there is a major failure with the Product, you are entitled to a replacement or refund. The benefits given to you by this warranty are in addition to your other rights and remedies under any laws which relate to the Product.
3. If the Product proves to be defective within the Warranty Period by reason of improper workmanship or material, we may, at our own discretion, repair or replace the Product without charge.
4. This warranty only applies to Tescom products purchased in Australia and sold by the Importer or its authorized retailers and dealers.
5. The warranty is invalidated under the following circumstances:
 - a. If the Product is not used in accordance with the instructions supplied or is misused;
 - b. If damaged after a fall or a shock;
 - c. If connected to a higher mains voltage supply;
 - d. If dismantled or tampered with in any way;
 - e. If the serial number or product plate is removed or defaced;
 - f. The Products have been serviced or otherwise repaired by a person not authorized to do so by us or where non-approved replacement parts are used.
6. This warranty does not cover loss of use of the Product or consequential loss of any nature.
7. Should you experience any difficulties with your Product, please send a written claim or email to info@tescom-japan.com.au. On receipt of your claim, we will seek to resolve your difficulties.
8. In order to claim under the warranty, you must:
 - a. retain this warranty with your receipt/proof of purchase. Your receipt/proof of purchase must indicate clearly the name and address of the Supplier, the date and place of purchase and the product name; and
 - b. return the Products to us to the address below by prepaid freight within the Warranty Period accompanied by a copy of your receipt/proof of purchase.
9. Any parts of the Products replaced during repairs or any product replaced remain the property of the manufacturer.
10. This Warranty does not cover the cost of claiming under the warranty or transport of the Products to and from You or the retailers to us.
11. The Products are designed for domestic use only. A limited 90-day warranty applies to any commercial use of the Products.
12. For further information or inquiries, contact us on:
 Care With You Pty Ltd
 PO Box 148
 ENFIELD NSW 2136 AUSTRALIA
 E: info@tescom-japan.com.au
 W: www.tescom-japan.com.au

REGISTRATION FORM

To register for your warranty, please complete and return this portion to Care With You Pty Ltd within 30 days of purchase.

Date of Purchase:	/	/		Mr	/	Mrs	/	Ms	/	Miss
Name of Retailer:									
Address of Retailer:	Surname Initial									
.....	Address:									
.....									
Model No.:	State: Postcode:									
Serial No.:	Tel:									
	Email:									